

ANCHOR CLIP DETAIL

NOTES:

- ① FACE = COVERAGE (SHOULD EXTEND A MIN. OF 1" BELOW WATERPROOFING MEMBRANE) + 1 3/8".
- ② 24 GA. GALV. AND .040" ALUM. COPING COVERS AVAILABLE FOR WALL SIZES 8" TO 24" ONLY.
- ③ WELDED ACCESSORIES REQUIRE A MINIMUM MATERIAL THICKNESS OF .050".
- ④ FOR NON 90° MITERS PLEASE USE PRINT APPROVAL #11011-1487.

AUTHORIZED SIGNATURE:

APPROVED BY: _____

DATE: _____

ANSI/SPRI ES-1 TESTED

U.S. PATENT # 8,978,317 B1

MATERIAL:

- ___ 24 GA. GALVANIZED STEEL ②
 - ___ 22 GA. GALVANIZED STEEL
 - ___ .040" ALUMINUM ②
 - ___ .050" ALUMINUM
 - ___ .063" ALUMINUM
 - ___ OTHER _____
- COLOR: _____
- FINISH: _____

QUANTITIES:

_____ LINEAL FEET 12'-0" LENGTHS

ACCESSORIES:

- ___ OUTSIDE MITERS @ 90° ④
- ___ INSIDE MITERS @ 90° ④
- ___ RIGHT ENDCAPS
- ___ LEFT ENDCAPS

SPECIFY ACCESSORY TYPE:

- WELDED ③
- QUICKLOCK

ENDWALL FLASHING (SPLICE PLATE VERSION)

RIGHT HAND _____ LEFT HAND _____

ENDWALL FLASHING (COPING VERSION)

RIGHT HAND _____ LEFT HAND _____

PROJECT:

ARCHITECT:

ROOFING CONTRACTOR:

REPRESENTATIVE/DISTRIBUTOR:

CORPORATE OFFICES, MANUFACTURING
1600 AIRPORT ROAD; WAUKESHA, WI 53188

PHONE: 800-558-2162
FAX: 800-373-9156

WEBSITE: WWW.METALERA.COM
EMAIL: QUOTE@METALERA.COM

DATE: 04/10/17

DRN BY: JJC

CKD BY: SAK

SHT.# ____ OF ____

DWG# 11011-21038

D

PERMA-TITE GOLD CANTILEVER COPING
STANDARD ACCESSORIES

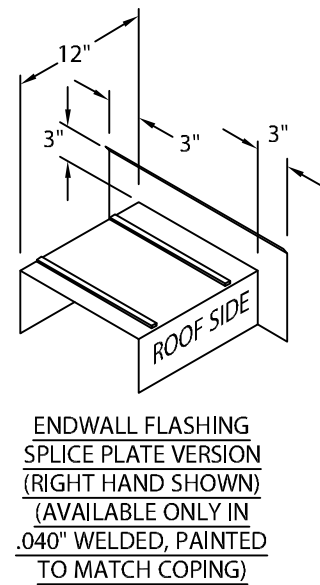
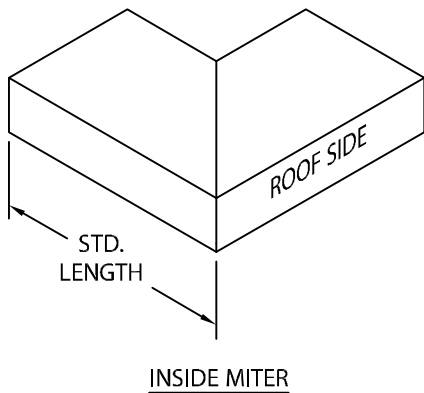
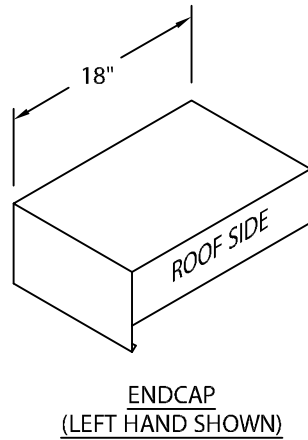
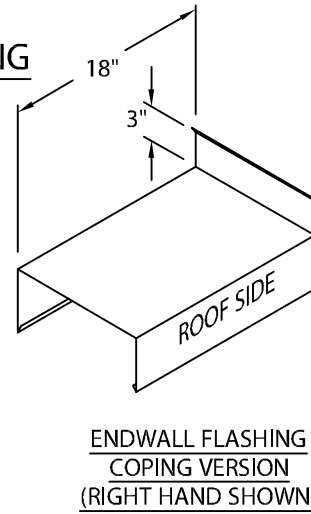
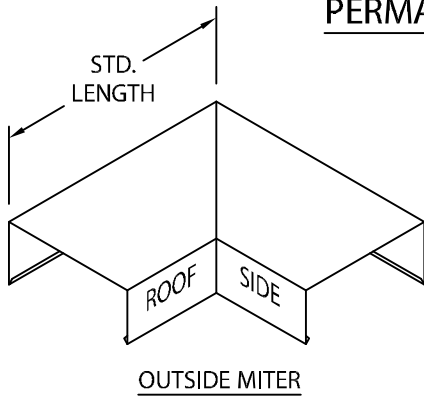

MITER STANDARD LEG LENGTH:
WALL SIZE + 9⁵/₈" = LENGTH

ADDITIONAL ACCESSORIES ARE AVAILABLE ON WEBSITE:

- TRANSITION MITERS
- STRAIGHT TRANSITION MITERS
- "T" MITERS
- "Z" MITERS
- STEP-UP MITERS
- PEAK / VALLEY MITERS
- PILASTER CAPS
- RADIUS COPING
- ARCHED COPING

(FOR ADDITIONAL ACCESSORY REQUIREMENTS, ATTACH SKETCHES OR CALL MANUFACTURER FOR ASSISTANCE).